

CHAPTER 1**INTRODUCTION**

The PCCOM 8 port adapter provides eight asynchronous serial communication ports (RS232 or RS422), which link the computer and serial peripheral devices such as terminals, modems, serial printers, plotters, ... etc.

The PCCOM 8 port adapter is particularly suited to facilitate the connection of terminals (VDUs) in multi-user operating systems. Each board is supplied complete with many kinds of connectors.

The PCCOM board may be installed in any PC/486, Pentium or hardware compatible systems. To accommodate a variety of operating systems, three switch banks permit maximum flexibility of configuration. You may select which interrupt (IRQ2 - IRQ7), I/O address, and interrupt vector you desire.

The PCCOM 8 port board can be used to plug in 8250, 16450, 16550, or 16650 chips, and the PCCOM device driver can detect it automatically. There are two kinds of board can be choose, one is normal speed card that its baud rate up to 115200, another is high speed card that its baud rate up to 460K.

The features of the PCCOM 8 port adapter are:

- Eight RS232 or RS422 ports for asynchronous communications.
- Suitable for XENIX/UNIX (SCO, AT&T, Interactive, UNIXWARE), MS/DOS, WINDOWS/NT, WINDOWS/95, WINDOWS/98, WINDOWS/2000, OS/2, MS/WINDOWS, PICK, CONCURRENT DOS, QNX, PROLOGUE, MUMPS, ... etc.

- PC/486, Pentium hardware compatibles.
- Interrupt selectable. (IRQ2 - IRQ7)
- Interrupt vector address selectable.
- ARNET 8 multi-port card compatible.
- I/O address selectable.
- Auto-detect 16450 or 16550 or 16650 chips on board.
- Baud rate up to 115200 for normal speed board and up to 460K for high speed board.

CHAPTER 2

UNPACKING INFORMATION

☞ **Check that your PCCOM package includes the following items:**

- PCCOM 8 port adapter.
- User manual.
- Decision Studio CD for PCCOM software.
- Connector.
Select one of follow items.
 1. DB25 connector.
 2. DB9 connector.
 3. RJ-11 connector.
 4. Expansion box with DB25 connector.
- Warranty form.

CHAPTER 3

SYSTEM REQUIREMENTS

☞ **Before installing your PCCOM 8 port adapter, make sure that:**

- The host computer is PC/486, or Pentium compatibles.
- The three switch blocks are correctly configured to coincide with the operating system you are using.
- The operating system you intend to use is capable of driving multiple serial ports.

CHAPTER 4**HARDWARE INSTALLATION**

Your PCCOM 8 port adapter is designed to be inserted in any available slot in your PC/486, Pentium or compatibles. In order to gain access to the expansion slots, follow the steps listed below:

1. Turn off all power to your computer and all peripheral devices before installing your PCCOM 8 port adapter.
2. Remove the cover of the computer.
3. Insert the pre-configured PCCOM 8 port adapter into any available slot. Make sure the adapter is firmly seated in the chosen slot.
4. Replace the cover of the computer.
5. Connect cables to eight RJ11, DB9, or D25 connectors as required.

CHAPTER 5**SWITCH SETTING****5.1 Introduction**

The three switch blocks and two jumpers on the PCCOM 8 port adapter must be configured correctly in accordance with the operating system you are using.

SW1 (Switch 1)

Determines the I/O address of the UARTs.

SW2 (Switch 2)

Selects which interrupt will be used in the range IRQ2 through IRQ7.

SW3 (Switch 3)

Selects the interrupt vector address and determines which port is active when an interrupt occurs.

JP1 (Jumper 1)

Select master or slave board.

JP2 (Jumper 2)

Daisy chain jumper for installing more than one boards which use the common IRQ.

All addresses specified are in hexadecimal. The actual interrupt latch address is set to the interrupt vector address set by switch 3 + 2H.

PC COM 8 PORT RS-232 CARD RJ-11 BOARD

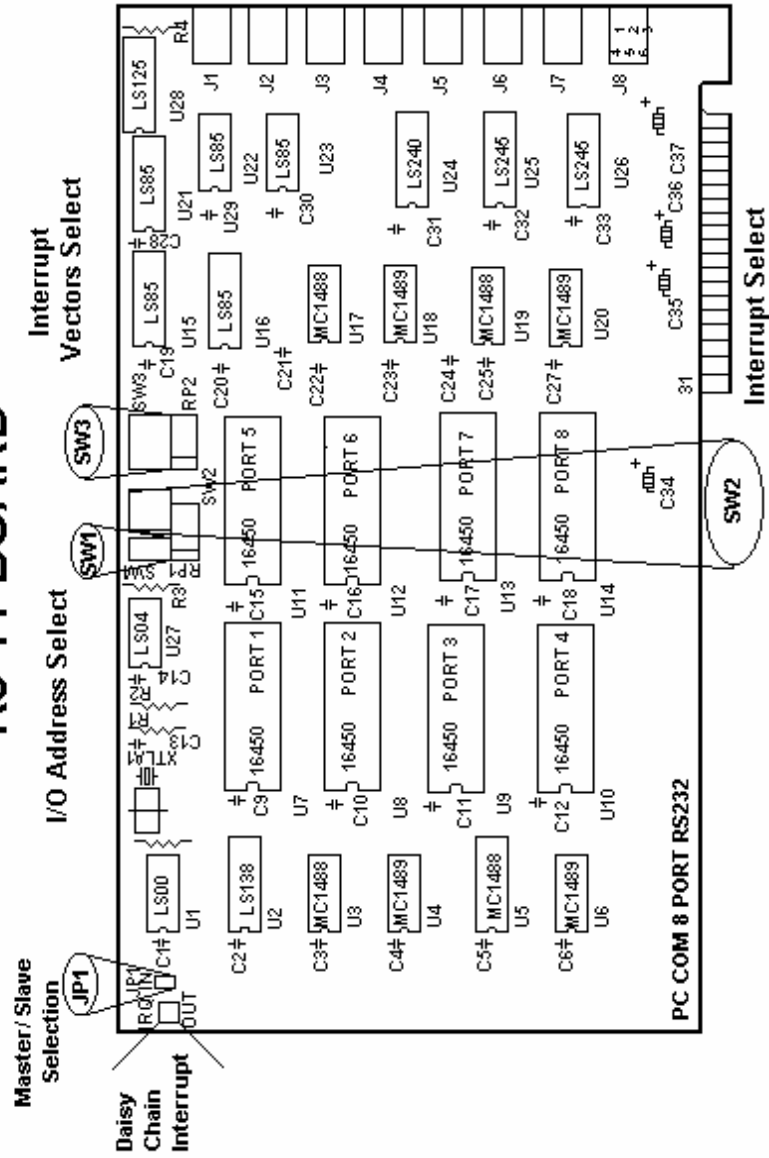

PC COM 8 PORT RS-232/422 CARD DB37 PIN BOARD

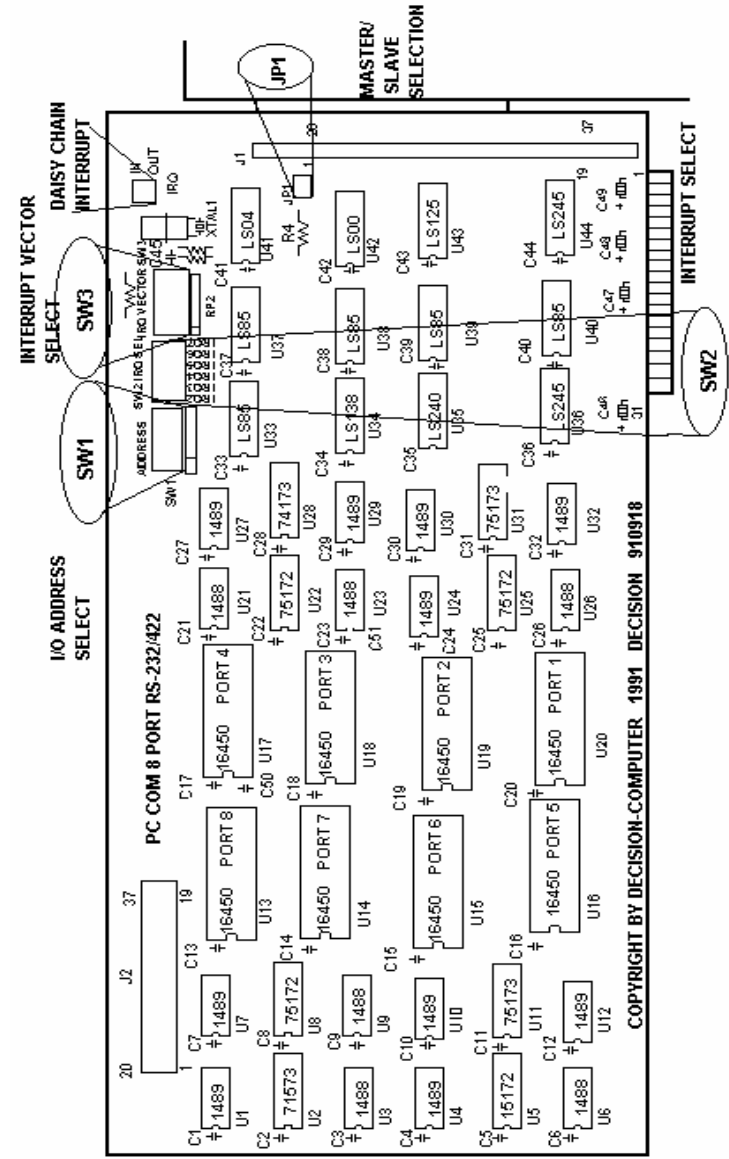

5.2 Selection of Switch Settings

It is important to refer to the user manual supplied with your operating system to determine the correct configuration. Although we provide installation advice for various operating systems, it is not possible to cover all systems in this user guide. Please contact your supplier if you have any difficulties with configuration.

IMPORTANT: CARE MUST BE TAKEN IN SELECTING THE CONFIGURATION OF SWITCHS TO ENSURE YOU DO NOT DUPLICATE SETTINGS OF OTHER EQUIPMENT ALREADY INSTALLED IN YOUR COMPUTER. DUPLICATION OF SETTINGS WILL RESULT IN A MALFUNCTION OF ONE OR BOTH DEVICES.

Please refer to the following settings for each switch block. If you are installing more than one board, do not duplicate jumper settings for any parameter.

I/O PORT ADDRESS (UART ADDRESS)

SWITCH 1

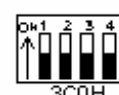
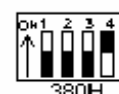
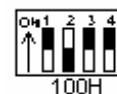
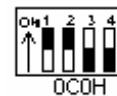
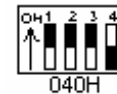

NOTE: The address selected must start on a multiple of 40H. A block of 40H contiguous I/O locations will be used starting from the selected address.

The I/O port addresses corresponding to each port are shown in the following.

PORT	ADDRESS
1	BASE to BASE+07
2	BASE+08H to BASE+0FH
3	BASE+10H to BASE+17H
4	BASE+18H to BASE+1FH
5	BASE+20H to BASE+27H
6	BASE+28H to BASE+2FH
7	BASE+30H to BASE+37H
8	BASE+38H to BASE+3FH

INTERRUPT (IRQ)

SWITCH2



IRQ2

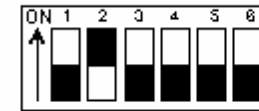

IRQ3

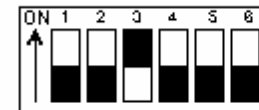

IRQ4

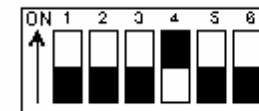

IRQ5



IRQ6



IRQ7



INTERRUPT VECTORS



000H



010H



020H

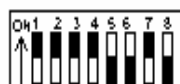

030H

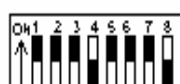

040H



050H

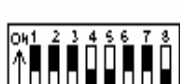

060H

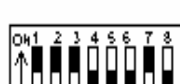

070H

SWITCH 3

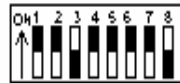

080H

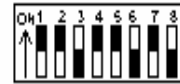

090H

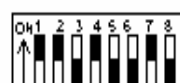

0A0H

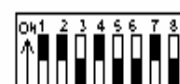

0B0H

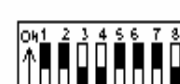

0C0H

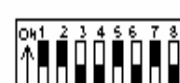

0D0H

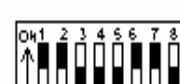

0E0H

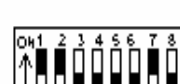

0F0H



100H

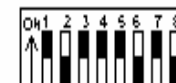

110H



120H



130H



140H



150H

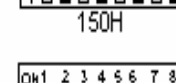

160H

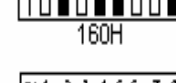

170H



180H

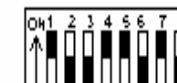

190H

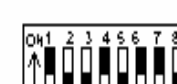

1A0H



1B0H

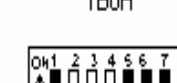

1C0H

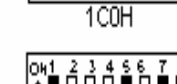

1D0H

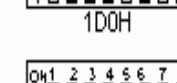

1E0H



1F0H





200H



210H



220H

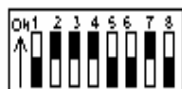

230H

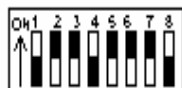

240H

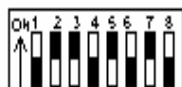

250H



260H



270H

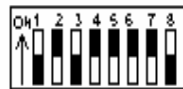

280H



290H

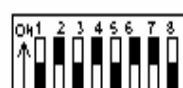

2A0H

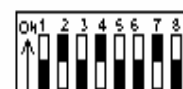

2B0H

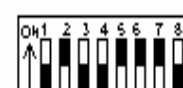

2C0H

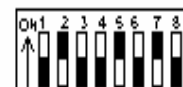

2D0H

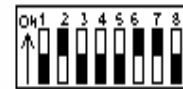

2E0H



2F0H



300H



310H

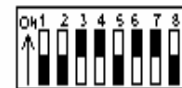

320H

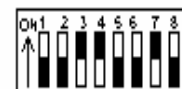

330H

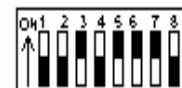

340H

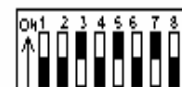

350H

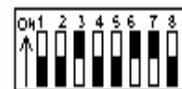

360H



370H



380H



390H

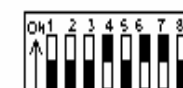

3A0H

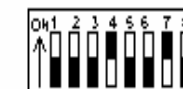

3B0H

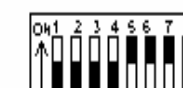

3C0H

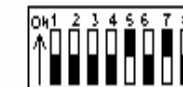

3D0H

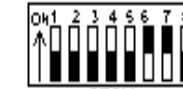

3E0H



3F0H



OFF



5.3 Daisy Chain Interrupt

The daisy chain interrupts function provides more than one PC COM 8 port board to use the common interrupts.

The JP1 is used to identify master or slave board, and the JP2 (IN/OUT) is used to connect daisy chain.

JP1: Select master or slave

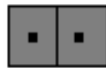

JP1	Board
Short	Master
Open	Slave

Suppose you used one common interrupt to serve 24 ports, it must select one board as master board that generates interrupt, and the other two boards as slave. It shows how to connect daisy chain interrupt in the following.

DB37 Pin Board

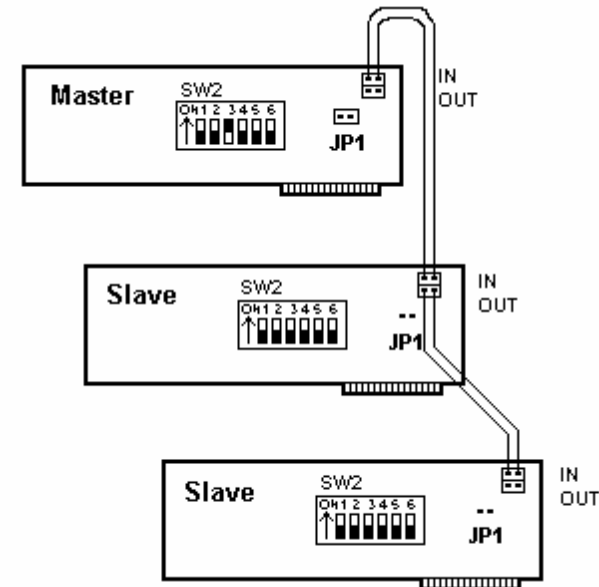

NOTE THAT, WHEN THE DAISY CHAIN FUNCTION IS USED, ONLY SET INTERRUPT (SWITCH 2) ON MASTER BOARD, DO NOT SET IRQ ON SLAVE BOARD.

CHAPTER 6

RS232 & RS422 CABLING INFORMATION

6.1 RJ11 Connector

The communication interface follows the EIA RS232C standard. Each RS232 port has one RJ-11 female connector for connection to a peripheral device. The board-mounted female RJ-11 pin identification is shown in the following:

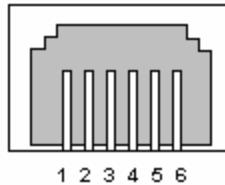

RJ - 11 Pin #	SIGNAL NAME	RS -232C NAME	SIGNAL DIRECTION
1	Chassis Ground (GND)	AA	Common
2	Signal Ground (SG)	AB	Common
3	Transmit Data (TxD)	BA	Output
4	Receive Data (RxD)	BB	Input
5	Clear to Send (CTS) Data Set Ready (DSR)	CB CC	Input
6	Data Terminal Ready (DTR)	CD	Output

The RJ-11 to DB25 expansion cable assignment is shown in the following:

RJ-11 Pin #	SIGNAL	DB25 Pin #
1	GND	1
2	SG	7
3	TxD	2
4	RxD	3
5	DSR & CTS	5,6
6	DTR	20

To connect PCCOM 8 port adapter to other DATA TERMINAL EQUIPMENT (DTE) devices, the developers recommend the following connection method.

RJ-11 Signal

Terminal Signal

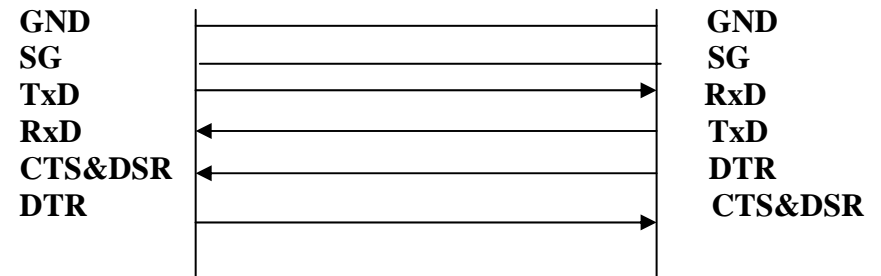

6.2 DB25 Connector

The communication interface follows the EIA RS232C standard. The signal assignments for a standard DB25 connector are shown below:

DB25 Pin #	Signal Name	RS-232C Name	Signal Direction
1	Chassis Ground(GND)	AA	Common
2	Transmit Data(TxD)	BA	Output
3	Receive Data(RxD)	BB	Input
4	Request to Send(RTS)	CA	Output
5	Clear to Send(CTS)	CB	Input
6	Data Set Ready(DSR)	CC	Input
7	Signal Ground(SG)	AB	Common
8	Data Carrier Detect(DCD)	CF	Input
20	Data Terminal Ready(DTR)	CD	Output

37 – PIN D-SHELL

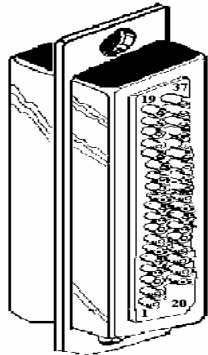

25 – PIN D-SHELL

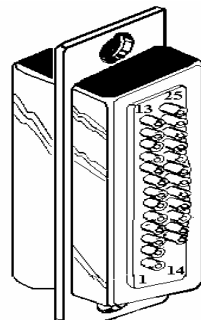

To connect the PCCOM 8 port adapter to other DATA TERMINAL EQUIPMENT (DTE) devices, we recommend using a DTE to DTE connection as shown below:

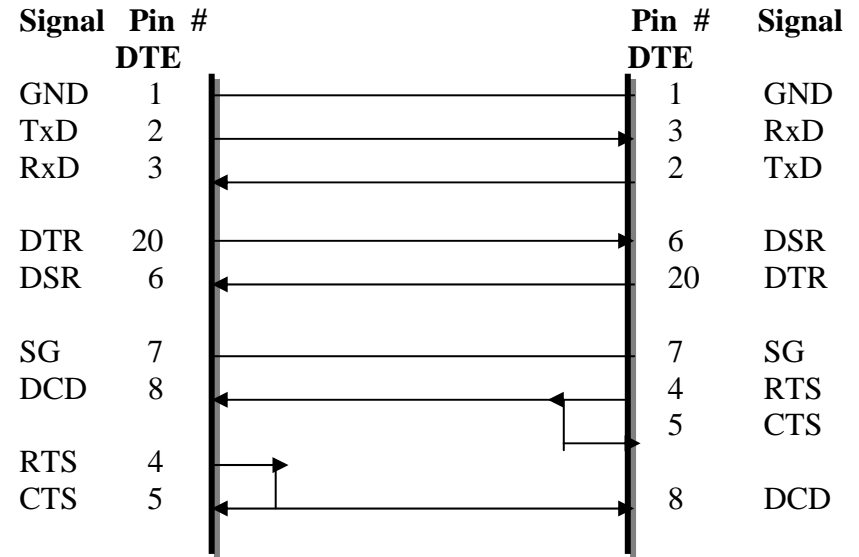

6.3 Null Modem Connections: RS232

If the software supplier or operating system does not specify a particular cable configuration, we recommend you use the following “null modem” cable when XON/XOFF is utilized.

HOST	REMOTE
2	3
3	2
4	4
5	5
6	6
7	7
8	8
20	20

If hardware handshaking is necessary, use the following cable:

HOST	REMOTE
2	3
3	2
4	4
5	5
6	20
7	7
8	8
20	6

Some serial devices have the buffer control signal on pin 19, in which case pin 6 on the host is connected to pin 19 on the remote device.

6.4 Modem Connections

A straight through cable is required, e.g. pin 2 to pin 2, pin 3 to pin 3, etc.

HOST	REMOTE
2	2
3	3
4	4
5	5
6	6
7	7
8	8
20	20

6.5 DB9 Connector

The signal assignments for a standard DB9 connector are shown below:

DB9 Pin #	Signal Name	RS-232C Name	Signal Direction
1	Data Carrier Detect(DCD)	CF	Input
2	Receive Data(RxD)	BB	Input
3	Transmit Data(TxD)	BA	Output
4	Data Terminal Ready(DTR)	CD	Output
5	Chassis Ground(GND)	AA	Common
6	Data Set Ready(DSR)	CC	Input
7	Request to Send(RTS)	CA	Output
8	Clear to Send(CTS)	CB	Input
9	Ring Indicator(RI)	CE	Input

6.6 RS422 Connector

The signal assignments for a standard DB25 connector are shown in the following.

Pin	Description
1	Shield Ground
2	Transmit Data(+)
3	Receive Data(+)
4	Request to Send(+)
5	Clear to Send(+)
6	Clear to send(-)
7	Ground
8	Transmit Data(-)
20	Request to Send(-)
22	Receive Data(-)

To connect the RS422 to other DATA TERMINAL EQUIPMENT (DTE) devices, the developers recommend using a DTE to DTE connection as shown below.

HOST	REMOTE
Ground	Ground
Transmit Data(+)	Receive Data(+)
Receive Data(+)	Transmit Data(+)
Transmit Data(-)	Receive Data(-)
Receive Data(-)	Transmit Data(-)
Request to Send(+)	Clear to Send(+)
Clear to Send(+)	Request to Send(+)
Request to Send(-)	Clear to Send(-)
Clear to Send(-)	Request to Send(-)

CHAPTER 7

INTERRUPT LATCH ADDRESS

The interrupt latch address is used to detect which of the eight channels is creating the interrupt. The interrupt latch address is set to the interrupt vector address + 2H. The relationship between each port corresponds to the interrupt indicator as shown in the following. When the corresponding bit is 0, an interrupt occurred, otherwise if the bit is 1, then no interrupt occurred.

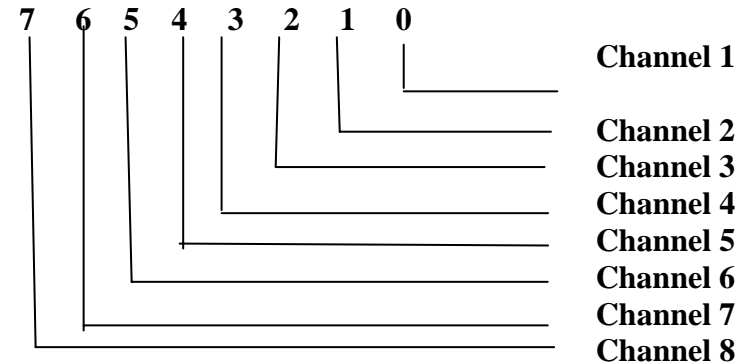

The interrupt vector must start on a multiple of 10H.

CHAPTER 8

SOFTWARE PACKAGE

In the Decision Studio CD, it contains PCCOM device driver for WINDOWS 3.1/95/98/2000/NT, DOS, OS/2, UNIX, Linux, and the development tools for serial communication and telecommunication.

8.1 PCCOM Professional

The PCCOM Professional is the Serial Communication Software Development Tool Kits Under Windows 95/98/2000/NT. It contains Complete OCX and DLL Microsoft Win32 API software accessory function for application software developer. It is an easy to use tool and speed up serial communication application software development time and cost. Wide compatibility range hardware support for PCCOM multiport serial card and any standard port, and support Zmodem and Kermit file transfer protocols for ASCII, Text and Executable file.

8.2 PCCOM RemoteCom

The PCCOM RemoteCom is an OCX programming development tool for made application software. That will use to enhance RS-232/422 serial communication through Internet or Intranet by stand-alone program or by browser through World Wide Web (WWW) under Windows 95/98/2000/NT. User may call OCX functions to communicate with RemoteCOM both Server and Client using Internet communication; or encapsulate OCX function and remote serial ActiveX Control, then run development application program under Internet browser (IE and Netscape).

8.3 PCCOM TeleCom

The PCCOM TeleCom is an OCX software accessory suitable for software engineer to develop application program under Windows 95/98/2000/NT environment. It really makes computer and communication application combine together. Wide compatibility range hardware support for PCCOM multiport serial card and any standard port. The PCCOM TeleCom software kit supports five major telecommunication functions, which can be used to

1. Send message to "PAGER"(BB Call).
2. Send and receive "VOICE MAIL" from computer to telephone or portable phone.
3. Send and receive E-MAIL.
4. Send and receive FAX.
5. Receive DTMF.

8.4 PCCOM RemoTeleCom

The PCCOM Remote TeleCom is an OCX programming development tool for made application software. That will use to enhance PCCOM TeleCOM functions (Pager, E-mail, Voice mail, Fax) through Internet or Intranet by stand-alone program or by browser through World Wide Web (WWW) under Windows 95/98/2000/NT. User may call OCX functions to communicate with Remote devices both Server and Client using Internet communication; or encapsulate OCX function and remote ActiveX Control, then run development application program under Internet browser (IE and Netscape).

8.5 PCCOM SCOPE

PCCOM SCOPE is a software that monitors all the data and signals between two interacting devices, or a single device. With PCCOM SCOPE you can transform your PC into a total RS-232 analyzer without the need of expensive hardware or plug in boards. PCCOM SCOPE creates an unsurpassed tool for RS-232 device driver, communications protocol and traffic analysis.

APPENDIX A

PC COM DIAGNOSTIC UNDER MS/DOS

The TESTCOM a diagnostic program, provide routines to test your PCCOM 8 port serial adapter under MS/DOS. It has both internal and external loopback tests. During external loopback test, a loop back plug must be connected to each port being tested. You can also select different hardware settings during testing from the SETUP RS232 menu.

User can get TESTCOM program from Decision Studio CD.

■ To test your PCCOM 8 port adapter under MS/DOS, please type

TESTCOM

The TestCom menu will appear.

Setup RS232 – is used to setup the baud rate, flow control, etc.

Internal loop test – is used to test the IC.

External loop test – is used to test the ports.

Auto – is used to test the IC and the ports of the card.

APPENDIX B

PCCOM DEVICE DRIVER FOR MS/DOS

B.1 PCCOM Software

The PCCOM software is a high performance, easy to use RS232/RS422 device driver for PC/486, Pentium or compatibles. Under MS/DOS environment, you can set up your serial ports by PCCOM device driver, and these serial ports can be treated as COM1: and COM2: devices. The setup procedure provides flexible functions to specify the configuration of multi-serial card, that is, the hardware configurations of I/O port number, I/O port address, interrupt and interrupt vector are user selectable.

After the device driver is installed, It takes over communication between CPU and multi-serial cards such as four port card, eight port card, ... etc. For each I/O port, the service routine handles a ring buffer to keep track of all I/O data. Moreover, the PCCOM software provides library routines (C, PASCAL, BASIC, FoxPro) and DOS communication interface (DOS device driver, BIOS call) for several access levels.

 For more details, please refer PCCOM manual.

B.2 Hardware Configuration



B.3 Software Installation

When the board is installed, please install software drivers as follows:

STEP 1: Prepare PCCOM8.OPT file

The PCCOM8.OPT file contents are :

```
/B:2
/D:COM3
/A:[4:280,8,2C2,LO:(2k:9600:N-8-1:RTS+DTR:XON) * 8]
```

STEP 2: Prepare CONFIG.SYS file

Insert statement into CONFIG.SYS file

```
DEVICE = PCCOM.SYS @c:\pccom8.opt
```

 If more than one PCCOM board is installed, Please refer to PCCOM manual.

APPENDIX C

XENIX/UNIX CONFIGURATION

The distribution CD contains SCO, AT&T, UNIXWARE, and INTERACTIVE UNIX/XENIX driver, it detects non-FIFO or FIFO chips automatically. Our drivers also provide transparent printer features that let user to connect local printer from auxiliary port of terminal. The hardware configuration and software installation procedures are shown in the bellows.

C.1 Suggested Hardware Configuration

1. First adapter

I/O port address: 280H

Interrupt level: IRQ4

Interrupt vector: 2C0H

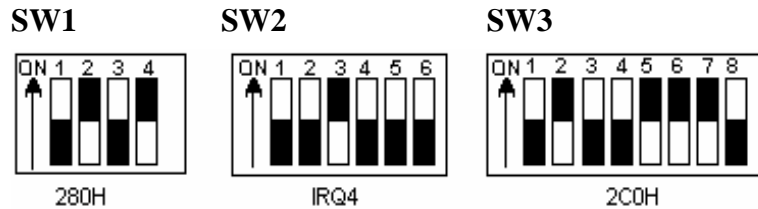

Port	Device Name	MODEM Name	Transparent Printer Name
1	/dev/ttyj11	/dev/ttyJ11	/dev/lpj11
2	/dev/ttyj12	/dev/ttyJ12	/dev/lpj12
3	/dev/ttyj13	/dev/ttyJ13	/dev/lpj13
4	/dev/ttyj14	/dev/ttyJ14	/dev/lpj14
5	/dev/ttyj15	/dev/ttyJ15	/dev/lpj15
6	/dev/ttyj16	/dev/ttyJ16	/dev/lpj16
7	/dev/ttyj17	/dev/ttyJ17	/dev/lpj17
8	/dev/ttyj18	/dev/ttyJ18	/dev/lpj18

2. Second Adapter

I/O port address: 240H

Interrupt level: IRQ3

Interrupt vector: 2D0H

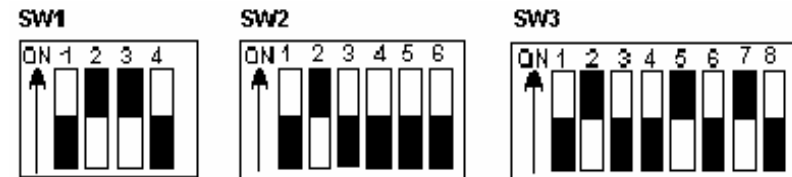



Port	Device Name	MODEM Name	Transparent Printer Name
1	/dev/ttyj21	/dev/ttyJ21	/dev/lpj21
2	/dev/ttyj22	/dev/ttyJ22	/dev/lpj22
3	/dev/ttyj23	/dev/ttyJ23	/dev/lpj23
4	/dev/ttyj24	/dev/ttyJ24	/dev/lpj24
5	/dev/ttyj25	/dev/ttyJ25	/dev/lpj25
6	/dev/ttyj26	/dev/ttyJ26	/dev/lpj26
7	/dev/ttyj27	/dev/ttyJ27	/dev/lpj27
8	/dev/ttyj28	/dev/ttyJ28	/dev/lpj28

C.2 Software Installation

i The installation procedure for the device drivers is described as follows:

- ❶ Login as a root user.
- ❷ Insert distribution CD (which contains device drivers) into CD-ROM drive d:, then copy the files from the distribution CD to a temporary directory.

```
#cd /
# doscp d:dc.tz ./dc.tar.Z ["dosget" in Interactive UNIX]
# zcat dc.tar / tar xvfp -
```

- ❸ To install device drivers, please type:

```
#cd /usr/sys/pccom/dc
# ./install
```



- ❹ Reboot the system. Now, your new UNIX system that includes device drivers is activated.
- ❺ Enable each terminal by using the **entty** or **enable** command. For USL UNIX (AT&T, UNIXWARE), Interactive UNIX

```
# entty ttyj11
# entty ttyj12
.
```

For SCO UNIX & XENIX by using **enable** command.

- ❻ Connect each terminal to connector.

NOTE:

- ❶ If the new system fails to reboot, please boot the original system. When system is boot, please press return key to halt autoboot, then type

```
:unix.old
```

- ❷ To remove device driver from UNIX, please type

```
a. login as a root user
b. # cd /usr/sys/pccom/dc
c. Remove PCCOM Driver from the kernel
#./ remove
```

- ❸ After installation, please enable each port by **entty** (for USL, Interactive UNIX) or **enable** (for SCO UNIX and XENIX)

command and disable port by **distty** (for USL, Interactive UNIX) or **disable** (for SCO UNIX and XENIX) command.

```
#distty ttyj11
```

- ④ To change baud rate, please update /etc/inittab and /etc/conf/cf.d/init.base files.

C.3 Option for High Speed

The configuration of High-Speed Baud Rate card is change as follows:

Original	Extensible
50	14.4 K
75	28.8 K
110	57.6 K
134	76.8 K
150	115.2 K
200	153.6 K
300	230.4 K
600	460.8 K
1200	1200 (unchanged)
2400	2400 (unchanged)
4800	4800 (unchanged)
9600	9600 (unchanged)
EXTA	19200 (unchanged)
EXTB	38400 (unchanged)

C.4 Transparent Printer

The default device names to Transparent Printer(TP) are /dev/lpXYY, that is, the prefix name is changed from "tty" to "lp" but the other "XYY" is the same. e.g. under default device names, the corresponding TTY line of /dev/lpj11 is /dev/ttyj11.

By multiplexing a serial line, there are two sorts of data channels for TTY data(by /dev/ttyXYY) and TP data(by /dev/lpXYY). If the /dev/ttyj11 is used for a TTY, it has to be enabled before you would like to print data through /dev/lpj11 to a printer that connected to the terminal that is operated via /dev/ttyj11.

The channel for TP data that is uni-directional is used to transmit the data from a host to a terminal only. The differentiates of TTY data and TP data in the same serial line is that TP data are encapsulated within a couple of PRINT-ON and PRINT-OFF escape strings that are recognized by connected terminals. The PRINT-ON and PRINT-OFF is defined by connected terminals.

The scheme to multiplex a serial line for these two channels is based on time-division method. The time slices for TTY or TP data are generated according to the entry procedure, polling, in the PCCOM driver, which is periodically called by system clock. The period of system clocks is different among various operating systems, e.g. most UNIXs is 100hz, but SCO Xenix is 50hz.

The interval reserved for TTY or TP channel in the same serial line is important to output TP data to a low-speed printer through high-throughput line from PCCOM cards if there is no flow control XON/XOFF to the serial line.

The `lpx` command is used to adjust the time interval for TTY or TP data and the TP protocol.

```
lpx [option] device name
```

- **option:**

```
-t number: set interval for TTY
-l number: set interval for Transparent Printer
-n string: set esc string to turn on printer
-f string: set esc string to turn off printer
-T : get interval for TTY
-L : get interval for Transparent Printer
-N : get esc_string to turn on printer
-F : get esc_string to turn off printer
```

- **device_name : lpXYY**

The range of interval reserved for TTY or TP channel is from 1 to maximum integer. The default setting for any `/dev/lpXYY` is as follows:

```
Interval for TTY : 50
Interval for TP : 1
PRINT - ON escape : "\033[5i" (ESC[5i)
PRINT - OFF escape : "\033[4i" (ECS[4i)
```

☞ **The examples to invoke `lpx`**

- ① Set 60 time slices reserved for `/dev/ttyj11`

```
# lpx -t 60 /dev/ttyj11
```

- ② Set 2 time slices reserved for `/dev/lpj11`

```
# lpx -l2 /dev/lpj11
```

- ③ Get the time slices reserved for `/dev/lpj11`

```
# lpx -L /dev/lpj11
```

- ④ Set PRINT-ON string for `/dev/lpj11`

```
# lpx -n "\033[5i" /dev/lpj11
```

- ⑤ Get PRINT-OFF string for `/dev/lpj11`

```
# lpx -F /dev/lpj11 \033[4i
```

APPENDIX D

MS-WINDOWS CONFIGURATION for V3.x

The PCCOM 8 port device driver for MS/WINDOWS works for 8250, 16450, 16550 (FIFO), 16650 etc. User can set up any address to PCCOM 8 port card, and the address must be set to consecutive.

D.1 Installation

1. You may set arbitrary I/O address and interrupts. However, we suggest you use the following:

I/O port address = 280H

Interrupt = IRQ5

Interrupt vector = 2C0H

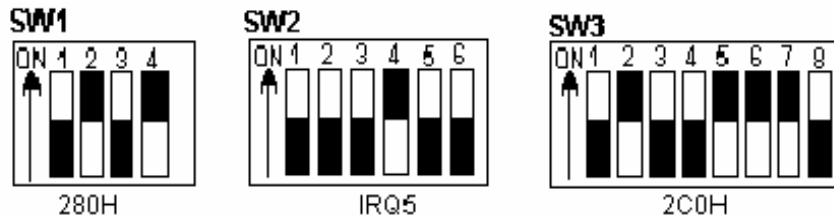

PORT	ADDRESS
1	280 – 287
2	288 – 28F
3	290 – 297
4	298 – 29F
5	2A0 – 2A7
6	2A8 – 2AF
7	2B0 – 2B7
8	2B8 – 2BF

2. Insert the distribution CD to CD-ROM drive, then run PCCOMW.EXE.
3. Select [Install].
4. Select the source path and the directory you want to install in it.
5. When copy file is finish, enter to configuration window.
6. Select your card type and the correct address/ IRQ value, then press [OK].
7. When the window presents 'complete', please restart Windows to let the driver work.

D.2 Uninstall

1. Enter Windows to run PCCOMW.EXE by click on PCCOM icon.
2. Select [Uninstall], and confirm that sure to uninstall.
3. When the window shows 'Uninstall complete', restart Windows to let old driver work.

D.3 Utilities

1. Programming Manual

Since window manager can recognize only COM1 to COM9, however, to install PCCOM 8 port card, it may occupy COM3 to COM10. In the distribution CD, we provide DLL library and include file, all functions are similar to USER.EXE functions.

Files:	COMM.X.DLL (Dynamic linked library for aux COMs)
	COMM.X.LIB (Static library for aux COMs API)
	COMM.X.H (The include file for C/C++)
	COMM.X.DOC (Document)

PCCOM library functions are similar to API Comm function

API functions are ???COMM???)
 PCCOM functions are ???COMMx???)

For example, OpenComm() become OpenCommX() , parameters are the same.

- Following are the functions used with communications devices.

```
int FAR PASCAL _export BuildCommXDCB(LPCSTR, DCB FAR*);
int FAR PASCAL _export OpenCommX(LPSTR, UINT,
UINT);
int FAR PASCAL _export CloseCommX(int);
int FAR PASCAL _export ReadCommX(int, LPSTR , int);
int FAR PASCAL _export WriteCommX(int,LPSTR , int);
int FAR PASCAL _export UngetCommXChar(int, char);
int FAR PASCAL _export FlushCommX(int, int);
int FAR PASCAL _export TransmitCommXChar(int, char);
int FAR PASCAL _export SetCommXState(const DCB FAR*);
int FAR PASCAL _export GetCommXState(int, DCB FAR*);
int FAR PASCAL _export GetCommXError(int, COMSTAT FAR* );
int FAR PASCAL _export SetCommXBreak(int);
int FAR PASCAL _export ClearCommXBreak(int);
UINT FAR* FAR PASCAL _export SetCommXEventMask(int,
UINT);
UINT FAR PASCAL _export GetCommXEventMask(int, int);
LONG FAR PASCAL _export EscapeCommXFunction(int, int);
```

```
BOOL FAR PASCAL _export EnableCommXNotification(int,
HWND, int, int);
```

2. Under standard WINDOW environment, to use "TERMINAL" and "CONTROL PANEL", only COM1 to COM4 can be used. If you need use COMx (more than COM4) with TERMINAL.EXE, please modify WIN.INI before enter to WINDOW. For example, to use COM6 with TERMINAL.EXE, please find

[TERMINAL]
 port=COMx

in WIN.INI, then modify port=COMx to port=COM6.

3. No modification are necessary for applications using up to COM9, and the printers , modems may be connected up to COM9.
4. **SPECIAL NOTE** : When you set 115200 baud(only with FIFOs), please set 0xFF20 (or CBR_56000+1) to certain functions.

D.4 Testing

1. Open two terminal applications under Windows.
2. Open COM port for each terminal, and have the same configuration(baud, stop bit, protocol...) e.g.
 Open COM3 to one terminal (9600 baud, 1 stop bit, 8 data bit)
 Open COM4 to another terminal (9600 baud, 1 stop bit, 8 data bit)
3. Use 'NULL MODEM' method to connect the two ports.

4. Try to transmit and receive data between the two terminal windows.

APPENDIX E

WINDOWS 95/98 CONFIGURATION

The PCCOM 8 port adapter can be installed in the Windows 95/98 by using serial device driver in the distribution CD, and the device driver will detect 8250, 16450, 16550, 16650 chips automatically.

E.1 Installation

1. You may set arbitrary I/O address and interrupts. However, we suggest you use the following:

I/O port address = 280 H

Interrupt = IRQ5

Interrupt vector = 2C0H



PORT	ADDRESS
1	280 - 287
2	288 - 28F
3	290 - 297
4	298 - 29F
5	2A0 - 2A7
6	2A8 - 2AF
7	2B0 - 2B7
8	2B8 - 2BF

2. Insert the distribution CD into CD-ROM drive. The CD is auto run, so you just wait until Decision Studio Applet appears.
3. Click “Device Driver” button, “Windows Operating System” then a selection of windows operating system platform appears.
4. Click “Windows 95 / Windows 98” button to view the device list of different hardware products.
5. Select “PCCOM Multiport Serial Card”. Install shield will do installation, for you just click “Next” when windows prompts you to resume installation procedure.
6. Reboot your computer and go to [Program Menu Applet] to select [PCCOM 2000]. Under PCCOM 2000 click [PCCOM 2000] to configure your hardware.
7. Select the card that you want to install and set the proper I/O address, IRQ, and starting COM in the same settings in which you set your hardware configuration previously. The device driver will test the configurations you set and confirm if there are any conflicts found during installation of hardware. Then reboot the system.
8. Afterwards, you can check the added ports inside the [Control Panel Applet]\[System]\[Device Manager]\[Ports]. Furthermore, you can test in hyper terminal to perform loopback test. However, you must provide a loopback to perform this test.

☞ If you need install more than one card, please run [PCCOM 2000] again and use different I/O address, IRQ when installing again. Never try to install 2 or more cards at the same time for you will have errors in installation.

E.2 Remove Ports

1. Go to [Program Menu Applet] to select [PCCOM 2000].
2. Enter [PCCOM 2000] then click [Remove Ports] and all previously installed ports will be removed.

Another method to remove ports is:

1. Go to [Control Panel Applet]\[System]\[Device Manager]\[Ports].
2. Select the port you want to remove then press “Remove” to delete specified port. Reboot for changes to take effect.

E.3 Uninstall

1. Enter [Control Panel]\[Add/Remove Programs], select the [PCCOM 2000] and click [Add/Remove] button.



APPENDIX F

WINDOWS 2000 CONFIGURATION

The PCCOM 4 port adapter can be installed in the Windows 2000 by using serial device driver in the distribution CD, and the device driver will detect 8250, 16450, 16550, 16650 chips automatically.

F.1 Installation

1. Unplug your PC, open it and install one Decision PCCOM card.
2. Start your computer and wait until Windows 2000 is loaded.
3. Insert the device driver CD into your computer, and make sure Windows 2000 finds the drivers by eventually browsing through the directory structure of the CD.
4. For manual installation run SETUP.EXE under the START BUTTON\RUN\BROWSE on the CD-ROM directory DECISION\WINDOWS\WINDOWS2000\PCCOM\DRIVER or use windows explorer, then look for the file SETUP.EXE on the said directory
5. After the installation process, go to CONTROL PANEL\DECISION PCCOM ADAPTERS\ADD button, set the corresponding settings according to your hardware settings before, then click OK. The software will tell you if there is any conflict in the settings, if conflict occur, you may change jumper settings or the software setting by the CONTROL PANEL\DECISION PCCOM ADAPTERS

☞ If you need install more than one card, please run above procedure again. Never try to install 2 or more cards at the same time for you will have errors in installation.



F.2 Remove Ports

1. Go to [Control Panel Applet]\[Decision PCCOM Adapters].
2. Select the port you want to remove then press “Remove Port” to delete specified port. Reboot for changes to take effect.



APPENDIX G

OS/2 CONFIGURATION

Under OS/2 2.x and OS/2 Warp operating system, the PCCOM device driver provides total 96 ports and baud rate up to 115200. PCCOM also supports device driver for high speed card, and the baud rate can be up to 460800. The device driver works for 8250, 16450, 16550 (FIFO), 16650 etc. User can set up any address to PCCOM 8 port card, and the address must be set to consecutive.

G.1 Installation

The installation procedures are shown in the following.

1. Add command into CONFIG.SYS file then reboot.

```
DEVICE=C:\PCCOM8.SYS/Axxx,www /Iyy/Czz /4
```

- xxx The first I/O port address
- www The interrupt vector address
- yy IRQ2 to IRQ7
- zz Assign the first port name (1 to 92)
- 4 High speed card used only

- ☞ if "/C" is not use, the first port is COM3.
- ☞ if option /C1 or /C2 is use, the port COM1 or COM2 is a logical port but not compatible to COM1 or COM2 on a PC machine.
- ☞ I/O Vector address value has to shift 2 from the original value (ex. 2C0H is replaced by 2C2H).

2. To set up communication parameters, please use the MODE.COM command from OS/2, or use PCCOM.EXE command. We highly recommend to use PCCOM.EXE command, because MODE.COM can be used only for COM1 to COM9 and for maximum baud rate to 57600.

The PCCOM.EXE can be used to set COM1 to COM96. The syntax of PCCOM.EXE is the same as MODE.COM.

- For example :

1. Set two cards from COM3 to COM10 and COM11 to COM18.

```
DEVICE=C:\PCCOM8.SYS /A240,2C2/I5 /C3
DEVICE=C:\PCCOM8.SYS /A1A0,1C2 /I7 /C11
```

2. Set up communication parameters.

```
C:\PCCOM COMx:38400,N,8,1,TO=OFF,XON=OFF,
IDSR=ON, ODSR=ON, OCTS=ON, RTS=OFF,DTR=OFF
C:\PCCOM COMx:115200,N,1
```

G.2 Utilities

COMTEST.EXE is a general testing program for COM port. It will create the threads associated with each communication port that will be test. The testing function includes OPEN/CLOSE/READ/WRITE/Non-Destructive Read/Non-Destructive WRITE/Get Status/Device IOCTL. Due to lack of OS/2 API, Non-Destructive I/O is not support for OS/2 even this device driver has implemented this feature.

In the COMTEST program, you can use up-right arrow to choice the option, and use enter/escape to start/stop the program.

The ComSent/ComRecv are a pair of communication programs for testing the performance of communication port. You have to connect the test ports with a null modem before you test communication port. You can use PCCOM.EXE to change the parameters of communication port. Then use this program to test heavy (transmission) duty on communication port.

G.3 API Communication Functions

In the following, there are API communication functions, for more detail information, please refer to Control Program Programming Ref. of OS/2, and programming Guide Vol. I-III of OS/2.

 **DosClose** - Close a Handle to a File, Pipe, or Devices
#define INCL_DOSFILEMGR APIRET DosClose(HFILE
FileHandle);

 **DosDevConfig** - Get Information about Attached Devices
#define INCL_DOSPROCESS APIRET DosDevConfig(PVOID
pDeviceInfo, ULONG ulDeviceType);

 **DosDevIOctl** - Perform Control Function on a Device
Specified by an Opened Device Handle
#define INCL_DOSPROCESS APIRET DosDevIOctl(HFILE
DevHandle, ULONG ulCategory, ULONG ulFunction, PVOID
pParmList, ULONG ulParmLengthMax, PULONG
pParmLengthInOut, PVOID pDataArea, ULONG
ulDataLengthMax, PULONG pDataLengthInOut);

 **DosOpen** - Open a File
#define INCL_DOSFILEMGR APIRET DosOpen(PSZ
pszFileName, PHFILE ppFileHandle, PULONG pActionTaken,
ULONG ulFileSize, ULONG ulFileAttribute, ULONG
ulOpenFlag, ULONG ulOpenMode, PEAOP2 ppEABuf);

 **DosRead** - Read from a File, Pipe, or Device to a Buffer
#define INCL_DOSFILEMGR APIRET DosRead(HFILE
FileHandle, PVOID pBufferArea, ULONG ulBufferLength,
PULONG pByteRead);

 **DosWrite** - Write to a File from a Buffer
#define INCL_DOSFILEMGR APIRET DosWrite(HFILE
FileHandle, PVOID pBufferArea, ULONG ulBufferLength,
PULONG pByteWritte);

APPENDIX H

WINDOWS/NT CONFIGURATION for V3.51 up

The PCCOM 8 port adapter can be installed in the Windows NT by using serial device driver in the distribution diskette, and the device driver will detect 8250, 16450, 16550, 16650 chips automatically.

H.1 Installation

1. You may set arbitrary I/O address and interrupts. However, we suggest you use the following:

I/O port address = 280 H
 Interrupt = IRQ5
 Interrupt vector = 2C0H

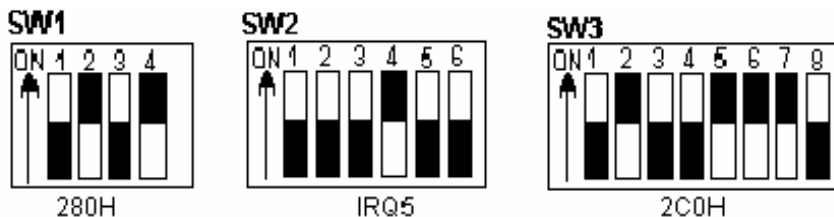

PORT	ADDRESS
1	280 – 287
2	288 – 28F
3	290 – 297
4	298 – 29F
5	2A0 – 2A7
6	2A8 – 2AF
7	2B0 – 2B7
8	2B8 – 2BF

2. Insert the distribution CD into CD-ROM drive. The CD is auto run, so you just wait until Decision Studio Applet appears.
3. Click “Device Driver” button, “Windows Operating System” then a selection of windows operating system platform appears.
4. Click “Windows NT” button to view the device list of different hardware products.
5. Select “PCCOM Multiport Serial Card”. Install shield will do installation, for you just click “Next” when windows prompts you to resume installation procedure.
6. Go to [Control Panel]\[Decision PCCOM Adapters]. Click [Add] then choose the hardware you want to install then reboot your computer.

☞ Configuration of I/O address, IRQ and interrupt vectors in your hardware must be the same inside the device driver configuration.

H.2 Remove Ports

1. Go to [Control Panel]\[Ports] then select what you want to remove and click “Delete” to remove ports.

H.3 Uninstall

1. Enter [Control Panel]\[Decision PCCOM Adapter], and click [Completely Remove Driver].

APPENDIX I

CONCURRENT DOS CONFIGURATION

MULTI - USER DOS CONFIGURATION

Set I/O port address to 280, interrupt to IRQ3 and interrupt vector to 270H. To install device drivers, please run the SETUP program, then follow the menu instructions to set up I/O port address, communication parameters (such as: baud rate, parity, data bits, ... etc.), and handshaking. The hardware configuration is shown below:

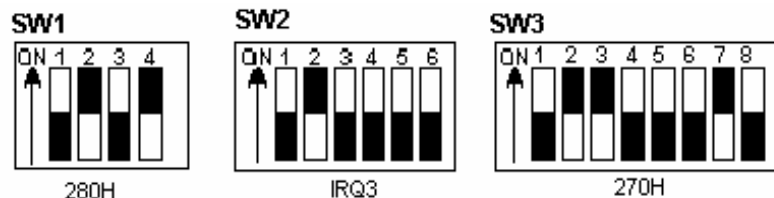

For multi-user DOS (Dr. DOS) configuration, set I/O port address to 280H, and interrupt vector to 270H. Any interrupt (IRQ3 to IRQ7) is used.

APPENDIX J

PICK CONFIGURATION

Refer to PICK user installation guide for more information. If selecting IRQ3 or IRQ4 be sure to disable existing COM1 or COM2 ports.

1. First board



2. Second adapter

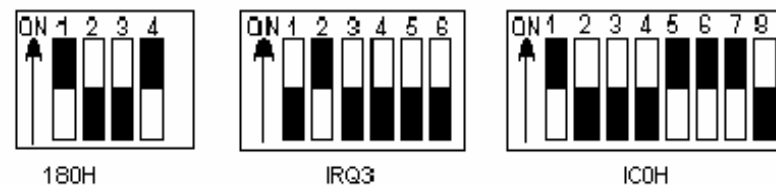

3. Third adapter

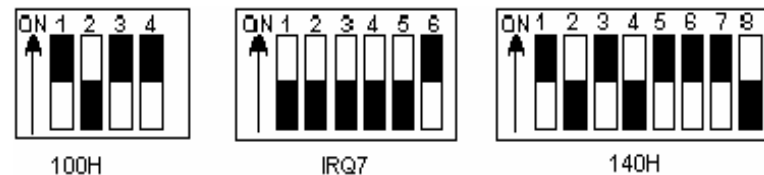

4. Fourth adapter

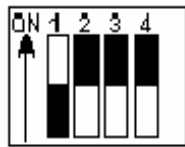

200H



IRQ2



240H

APPENDIX K

LINUX CONFIGURATION

The PCCOM 8 port adapter can be installed in the Linux by using serial device driver supported by Linux, and the device driver will detect 8250, 16450, 16550, 16650 chips automatically. For more details, please refer to 'setserial' man-pages.

I/O port address = 2A0H

Interrupt = IRQ4

Chip type = 16550

☞ Please add the following lines to */etc/rc.d/rc.serial* or *rc.local* file.

```
SETSERIAL="/bin/setserial -b"
```

```
${SETSERIAL} /dev/cua16 uart 16550 port 0x280 irq 4
```

```
${SETSERIAL} /dev/cua17 uart 16550 port 0x288 irq 4
```

```
${SETSERIAL} /dev/cua18 uart 16550 port 0x290 irq 4
```

```
${SETSERIAL} /dev/cua19 uart 16550 port 0x298 irq 4
```

```
${SETSERIAL} /dev/cua20 uart 16550 port 0x2A0 irq 4
```

```
${SETSERIAL} /dev/cua21 uart 16550 port 0x2A8 irq 4
```

```
${SETSERIAL} /dev/cua22 uart 16550 port 0x2B0 irq 4
```

```
${SETSERIAL} /dev/cua23 uart 16550 port 0x2B8 irq 4
```

APPENDIX L

DIAGNOSTIC UNDER WINDOWS

After installing the PCCOM adapter to your computer, you can test it if it is functioning correctly via HyperTerminal (a Windows package communication program), or by using the Decision Terminal (a software of the Decision Computer International Co. Ltd.) included on the CD. Just make sure that there is a loop back plug connected to the COM Port under test.

L.1 Using Hyper Terminal

To test the card using the Hyper Terminal. Please do the following steps:

1. Run the HyperTerminal program.
2. During connection, the program will ask you to enter your name and choose an icon for the connection. Enter any name and select any icon.
3. After entering your name and selecting icon you will be ask for country code, area code, phone number and connect using what. Ignore all edit box except for the connect using, click the combo box and select Direct to COMx (You can use any port but usually the COM1 and COM2 is used by the computer motherboard).
4. Put the proper COM x properties.
5. You can now begin to type any message. Take note that whatever you type must appear to the textbox as long as

you have a loop back on the COM port of your card!

L.2 Using Decision Terminal

To test the card using the Decision Terminal. Please do the following steps:

1. Install the software using the Decision Studio (It is inside the CD AutoOpen program).
2. Run the program (Decision Terminal) at the program menu of the start menu.
3. Setup the COM port properties by selecting the setup option on the File menu.
4. You can now begin to type any message to transmit textbox. Take note that whatever you type must appear to receive textbox as long as you have a loop back on the COM port of your card.
5. You can also click the Test button to test your card automatically.

APPENDIX M**SOFTWARE DEVELOPMENT****INFORMATION**

We also provide other hardware with complete Internet/Intranet remote control software tool for more function availability

Decision Industrial Interface

The Decision Industrial Interface was created to provide a standard way to access the functionality provided by all data acquisition products.

Decision Industrial Control

Develop a program controlling the Industrial digital and analog cards remotely at any part of the world using the Internet technology! Done it in your application program or via Internet browser! It extends Decision Industrial Interface from single computer development environment to client-server development environment.

Remote Voice

Long distance call will not be expensive as before. There is no cheaper way to talk to your friend from another country than to talk through Internet! And the good news is that you can develop your own software with Remote sound!

Remote Chat

This development tool is used for chatting / communicating with another computer in the Internet / Intranet.

Remote White Board

This development tool uses client – server remote drawing board,

every client can shared their image drawn on server drawing board.

Remote Image Capture

This development tool allows you to capture images taken from the CCD camera via Internet.

Pinger

This development tool make it possible for you to make a program that check if your still connected to the network or internet and check the speed of the response of your connection!

Internet Location Server

This development tool is used to find an IP address of a particular client / computer in the Internet by just specifying its email address!

Remote Access Server

This development tool use to dial-up like and phone dialer technology, able to dial an ISP and monitor some of some IP address on network



APPENDIX M

WARRANTY INFORMATION

M.1 Copyright

Copyright 1999, 2000, 2001 DECISION COMPUTER INTERNATIONAL CO., LTD. All rights reserved. No part of PCCOM software and manual may be reproduced, transmitted, transcribed, or translated into any language or computer language, in any form or by any means, electronic, mechanical, magnetic, optical, chemical, manual, or otherwise, without the prior written permission of DECISION COMPUTER INTERNATIONAL CO., LTD.

Each piece of PCCOM package permits user to use PCCOM only on a single computer, a registered user may use the program on a different computer, but may not use the program on more than one computer at the same time.

Corporate licensing agreements allow duplication and distribution of specific number of copies within the licensed institution. Duplication of multiple copies is not allowed except through execution of a licensing agreement. Welcome call for details.

M.2 Warranty Information

DECISION warrants that for a period of one year from the date of purchase (unless otherwise specified in the warranty card) that the goods supplied will perform according to the specifications defined in the user manual. Furthermore that the PCCOM product will be supplied free from defects in materials and workmanship and be fully functional under normal usage.



In the event of the failure of a PCCOM product within the specified warranty period, DECISION will, at its option, replace or repair the item at no additional charge. This limited warranty does not cover damage resulting from incorrect use, electrical interference, accident, or modification of the product.

All goods returned for warranty repair must have the serial number intact. Goods without serial numbers attached will not be covered by the warranty.

Transportation costs for goods returned must be paid by the purchaser. Repaired goods will be dispatched at the expense of PCCOM.

To ensure that your PCCOM product is covered by the warranty provisions, it is necessary that you return the Warranty card.

Under this Limited Warranty, DECISION's obligations will be limited to repair or replacement only, of goods found to be defective as specified above during the warranty period. DECISION is not liable to the purchaser for any damages or losses of any kind, through the use of, or inability to use, the PCCOM product.

DECISION reserves the right to determine what constitutes warranty repair or replacement.

Return Authorization: It is necessary that any returned goods are clearly marked with an RA number that has been issued by DECISION. Goods returned without this authorization will not be attended to.

